



## Marine Engineers and Environmental Consultants

March 6, 2023

To: Wild Blue Community Development District c/o Chesley 'Chuck' Adams Jr.

From: Hans Wilson, P.E.

Copy: Carl Barraco

Subject: Hurricane Ian Retaining Wall Impacts Assessment

**INTRODUCTION** – Wild Blue is a master planned development (Lee County Resolution Z-15-021) located in southeast Lee County between Alico Road and Corkscrew Road in a mining area. The subdivision is located in a former mine that created a number of deep water lakes. The development is situated around the perimeter of the lakes and includes water access for vessels in the form of single family residential docks and community boat ramps.

The larger north lake is owned by Lennar Home LLC and the smaller south lake is owned by Pulte Home Company LLC. Access to the south lake is via a boat ramp located in the southwest corner of the lake south of the circle at Water Fern Way on Aqua Shore Drive. A second boat ramp was under construction in the northwest corner at the traffic circle at the end of Aqua Shore Drive. The north lake is accessible via community docks and a boat ramp located at the clubhouse on the western shore.

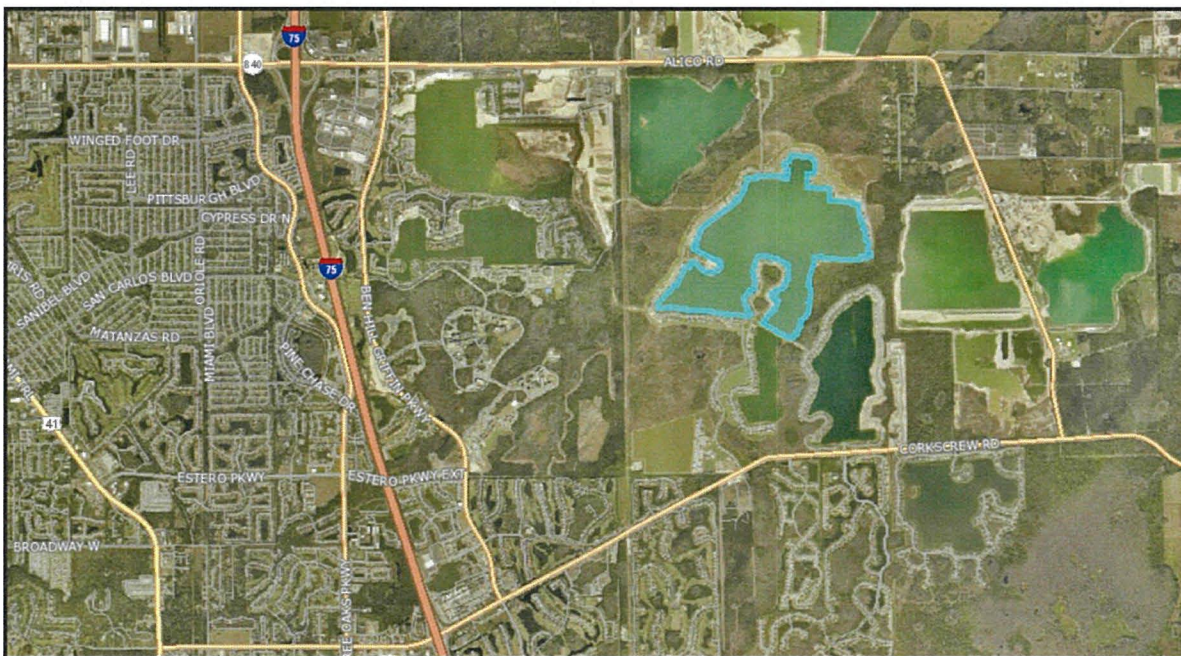

**Wild Blue north lake outlined in blue located east of I-75 between Alico and Corkscrew.**



**PURPOSE** – The purpose of this report was to assess the condition of a perimeter retaining wall damaged from Hurricane Ian on September 28, 2022. The development includes approximately 6.5 miles of retaining wall constructed to separate the upland stormwater management berm and residential development from the littoral shelves planted as part of the Lee County Development Order (DOS2018-00007 as amended). The stormwater management plan was approved by the South Florida Water Management District (Permit No.36-050765-P, as amended, issued on August 31, 2018).

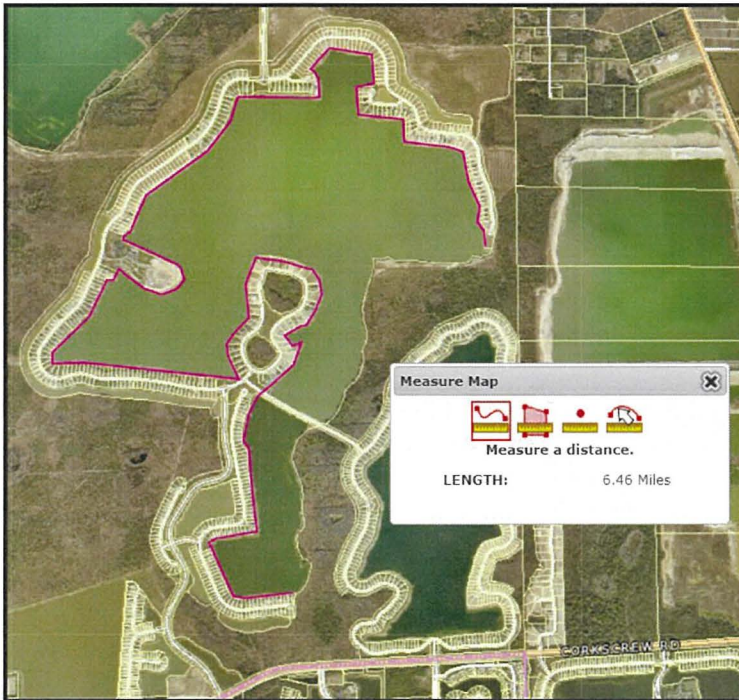

*To the left is a screen shot of the Lee County Property Appraisers (LEEPA) website showing the north and south lakes that are the subject of this report. The purple line denotes the general limits of the 6.5 miles of retaining wall.*

**HURRICANE IAN** – This tropical storm arrived in Lee County as a Category 4 hurricane with winds approaching 150 mph. The hurricane made landfall on the southwest coast of Cayo Costa, approximately 32 miles from the center of the north lake (see LEEPA screen shot below). A number of weather recording stations were lost during the hurricane, making it difficult to document the wind speeds and direction at the site.

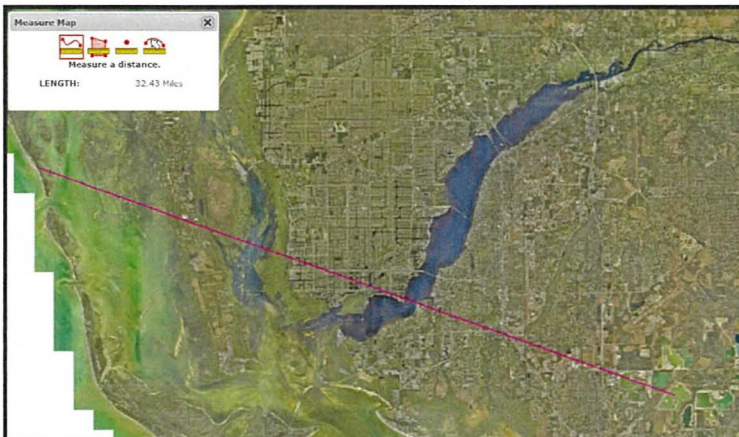



The counterclockwise rotation of the hurricane presented significant winds from the southeast, south, and southwest impacting the lakes. Below is a screen shot of the National Weather Service graphic showing landfall at Cayo Costa at 3:15 EDT. The approximate location of the project site is located by the red dot in the lower right of the graphic.

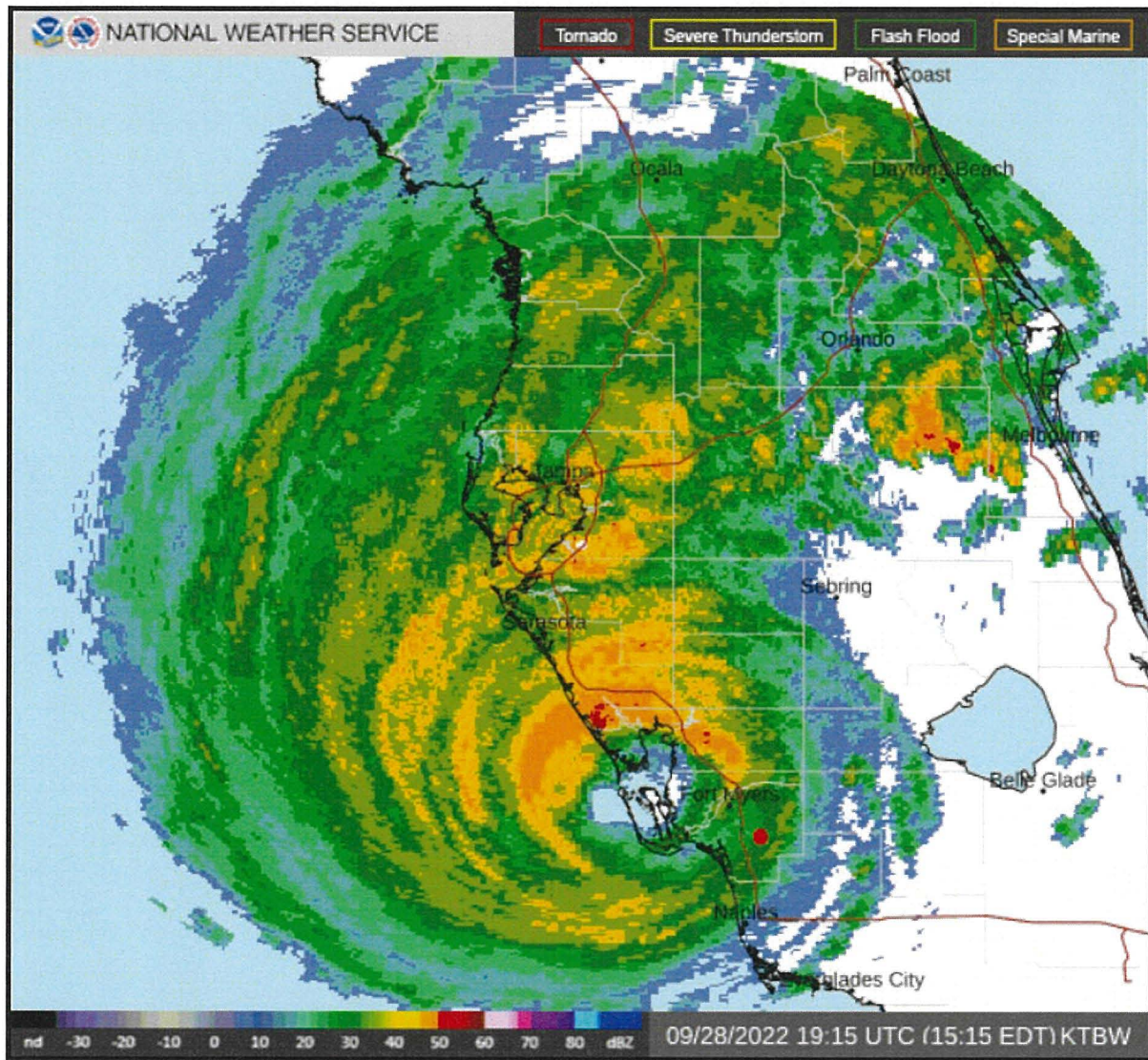

Weather records for Southwest Florida International Airport show sustained wind speeds increasing as the morning progressed, from 33 mph at 0900h. from the southeast, shifting to the south with sustained winds up to 64 mph at 1506 h. This occurred before the weather station quit recording. Gusts were up to 100 mph. The control tower for the airport is located almost four miles due north of the center of the lake. The north shorelines of the lakes were impacted by these heavy winds from the south for at least six hours, and very likely from the southwest as the hurricane continued its tract to the northeast.

**Below are the recordings from the airport showing sustained wind speeds, gusts, and wind direction.**

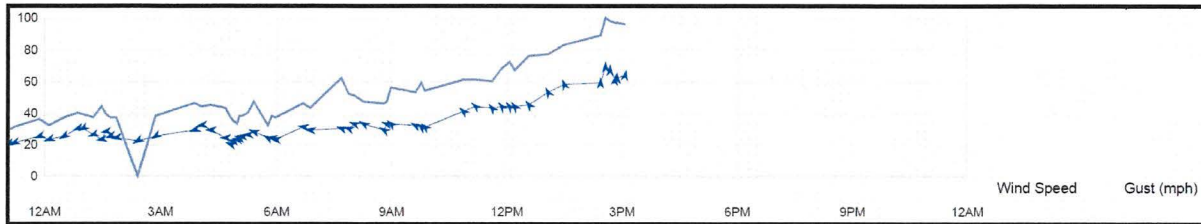

Time	Temperature	Dew Point	Humidity	Wind	Wind Speed	Wind Gust
9:00 AM	78 °F	76 °F	93 %	SE	33 mph	56 mph
9:38 AM	78 °F	76 °F	93 %	ESE	32 mph	53 mph
9:47 AM	79 °F	75 °F	89 %	SE	31 mph	59 mph
9:53 AM	78 °F	76 °F	93 %	SE	31 mph	54 mph
10:53 AM	78 °F	76 °F	93 %	SE	41 mph	61 mph
11:12 AM	77 °F	76 °F	96 %	SE	44 mph	61 mph
11:38 AM	78 °F	77 °F	96 %	SE	43 mph	60 mph
11:53 AM	77 °F	76 °F	96 %	SE	44 mph	68 mph
12:05 PM	77 °F	76 °F	96 %	SE	44 mph	72 mph
12:13 PM	77 °F	76 °F	96 %	SE	44 mph	67 mph
12:35 PM	77 °F	76 °F	96 %	SE	45 mph	76 mph
1:05 PM	77 °F	76 °F	96 %	SSE	53 mph	77 mph
1:30 PM	77 °F	76 °F	96 %	SSE	58 mph	83 mph
2:27 PM	77 °F	76 °F	96 %	S	59 mph	89 mph
2:35 PM	77 °F	76 °F	96 %	S	69 mph	100 mph
2:42 PM	77 °F	76 °F	96 %	S	67 mph	98 mph
2:50 PM	77 °F	75 °F	94 %	S	61 mph	97 mph
2:53 PM	77 °F	76 °F	96 %	S	62 mph	97 mph
3:06 PM	77 °F	76 °F	96 %	S	64 mph	96 mph

The wind speed and direction had a major impact on the lakes, creating waves moving from the south to the north along the longest axis of the lakes. The north shore of the south lake is revetted with limestone boulders and did not appear to be significantly affected by the hurricane. The north shore of the north lake was completely devastated from the resulting wave energy. Below are photos showing the alignment of the winds relative to the lakes from the south and the commensurate “fetch” distance across the lakes.



**Below left is a shot of the north lake and distance across the lake of almost 7,000 ft. Below right is a screen shot of the south lake and distance from north to south of almost 3,500 feet.**



**WAVE CALCULATIONS** – The U.S. Army Corps of Engineers Shore Protection Manual (SPM) Volume 1 is a resource that can be used to calculate wave height and period based on wind direction and speed. This is also tied to water depth. The depths in the lakes far exceed any influence on the wave energy produced by the hurricane until the wave reaches the shoreline. As a result the waves produced by the hurricane are fetch limited. To the right are the formulas used to calculate wave energy as a function of depth and distance. The SPM also has a number of graphics, example below, that are also used to assess wave energy based on multiple factors. This is another way to assess wave height and period.

$$\frac{gH}{U_A^2} = 0.283 \tanh \left[ 0.530 \left( \frac{gd}{U_A^2} \right)^{3/4} \right] \tanh \left\{ \frac{0.00565 \left( \frac{gF}{U_A^2} \right)^{1/2}}{\tanh \left[ 0.530 \left( \frac{gd}{U_A^2} \right)^{3/4} \right]} \right\}$$

$$\frac{gT}{U_A} = 7.54 \tanh \left[ 0.833 \left( \frac{gd}{U_A^2} \right)^{3/8} \right] \tanh \left\{ \frac{0.0379 \left( \frac{gF}{U_A^2} \right)^{1/3}}{\tanh \left[ 0.833 \left( \frac{gd}{U_A^2} \right)^{3/8} \right]} \right\}$$

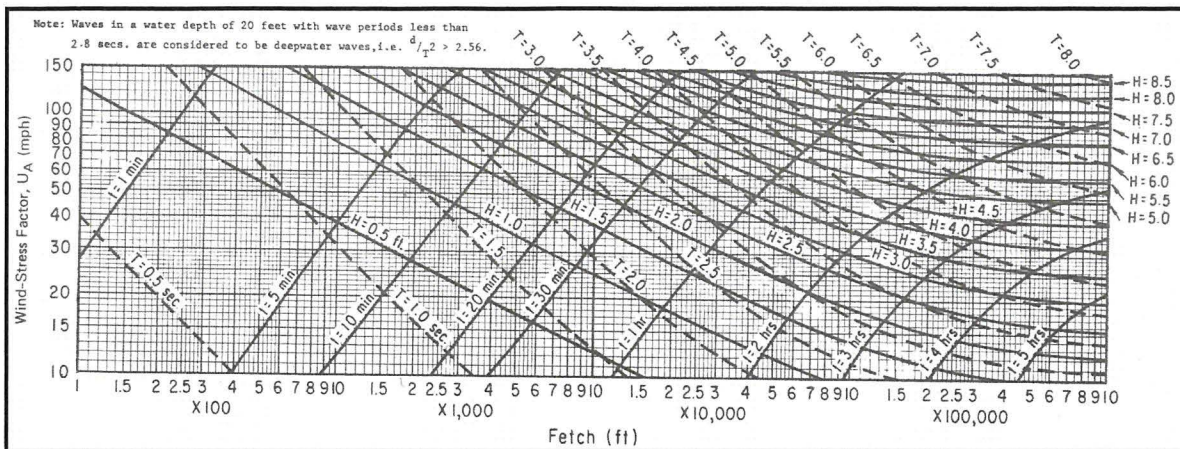

For a lake with depths approaching 20', a sustained wind speed between 60 and 70 mph and a fetch distance across the lake of 7,000 feet the resulting significant wave height and period is 3.2' and 2.7 seconds, respectively, for the north lake. This is based on the U.S. Geological Survey on line program that also allows you process these calculations in a more convenient manner. See results below.

### Fetch- and Depth-Limited Waves

This Javascript app implements Eqns. 3-39 and 3-40 from the *Shore Protection Manual*. Input is the wind speed  $u_{10}$  measured 10 m above the sea surface, the fetch  $f$ , and the water depth  $h$ . The calculations adjust wind speed to adjusted wind speed  $U_a$  according to Eqn. 3-28a before being used. Calculated results are significant wave height  $H_s$  and wave period  $T$ .

The calculations assume a flat bottom with depth  $h$ , and sufficient time for fully-developed seas. No checks are made to ensure that reasonable values are entered or that the calculations are within the applicable range.

#### Input

<b>Enter Parameters:</b>		<b>Units</b>
Wind Speed $u_{10}$	<input type="text" value="65"/>	(mph) <input type="button" value="v"/>
Fetch $f$	<input type="text" value="7000"/>	(ft) <input type="button" value="v"/>
Water depth $h$	<input type="text" value="20"/>	(ft) <input type="button" value="v"/>

#### Results

Significant wave height $H_s$	3.220	(ft) <input type="button" value="v"/>
Wave period $T$	2.721	(s) <input type="button" value="v"/>

#### Reference

Coastal Engineering Research Center (1984). *Shore Protection Manual*. U.S. Army Corps of Engineers, Waterways Experiment Station, Vicksburg Mississippi.

A similar calculation was run for the south lake, using a 3,500 foot fetch distance. The water depth are assumed to be 20' or greater, as reported by the site civil engineer. The resulting wave height and period was 2.4' and 2.2 seconds, respectively (see below).



## Fetch- and Depth-Limited Waves

This Javascript app implements Eqns. 3-39 and 3-40 from the [Shore Protection Manual](#). Input is the wind speed  $u_{10}$  measured 10 m above the sea surface, the fetch  $f$ , and the water depth  $h$ . The calculations adjust wind speed to adjusted wind speed  $U_a$  according to Eqn. 3-28a before being used. Calculated results are significant wave height  $H_s$  and wave period  $T$ .

The calculations assume a flat bottom with depth  $h$ , and sufficient time for fully-developed seas. No checks are made to ensure that reasonable values are entered or that the calculations are within the applicable range.

### Input

#### Enter Parameters:

Wind Speed  $u_{10}$

Units

(mph)

Fetch  $f$

(ft)

Water depth  $h$

(ft)

### Results

Significant wave height  $H_s$

2.360

(ft)

Wave period  $T$

2.196

(s)

### Reference

Coastal Engineering Research Center (1984). *Shore Protection Manual*. U.S. Army Corps of Engineers, Waterways Experiment Station, Vicksburg Mississippi.

For the south lake, the north shoreline is revetted with limestone boulders, which make it an articulating structure. As the wave energy reached the revetment the energy is dispersed omni-directional and the boulders shift or move as they absorb the waves. There did not appear to be any voids or significant shifts in the boulders. This is in part because the rock sizes are appropriate for this level of wave energy.



***This is a view of the riprap revetment along the causeway between the north and south lakes. Note that there are no voids or open areas indicating a shift from the incoming wave action, demonstrating the effectiveness of a revetment in attenuating waves.***

For the north lake, particularly the north shoreline, which exhibited significant damage to the retaining wall, we looked at the potential for scour at the base of the wall. With an estimated significant wave height of **3.2'** and wave period of **2.7** seconds, we can use the methodology outlined in the U.S. Army Corps of Engineers Coastal Engineering Manual (CEM) to assess scour. Scour on a vertical wall is greater than on a sloping surface. On a sloping surface an incoming wave has a certain amount of run up the slope that dissipates the wave energy, eventually causing the wave to break. The rougher the surface, like the revetment mentioned above, the greater the attenuation of the incoming wave.

With a vertical wall like a seawall, the incoming wave energy is distributed in two directions, vertically up into the air and vertically towards the bottom of the wall. The wave is also deflected back into the next incoming wave. As a result, the bottom or toe of the wall is scoured and supporting material fluidized and redistributed.

For breaking waves occurring on a shallow vertical wall the CEM provides equation VI-5-259: ( $S_M = H_{Max}$ ) where:

$S_M$  is the maximum scour depth at a vertical wall and  $H_{Max}$  is the nonbreaking wave height that can be supported by the water depth at the structure. For the north shoreline of the north lake there is/was a littoral shelf that, by design, was intended to slope down from the retaining wall to the limits of excavation of the lake, which then drops off almost vertically as a mine. The CEM suggests that a shallow sloping structure, such as the littoral shelf, will reduce the energy of an incoming wave and thus reduce the scour at the toe of the vertical wall. However, eventually there was no protection for the littoral shelf and it essentially was sacrificial to the wave energy. As the shelf eroded, the exposed face of the retaining wall increased, and eventually the incoming wave directly impacted the vertical retaining wall. This would be particularly true of the wave set up as it forced an artificial surge at the north end of the lake where incoming waves were above the littoral shelf.

The Coastal Engineering Manual Part 2, Chapter 4, Section 2 discussed this impact on breaking waves. Equation II-4-3 is provided below to calculate the depth where the wave breaks on the slope:

$$d_b = \frac{H_b}{\gamma_b} = \frac{3.2'}{0.78} = 4.1'$$

Whereas:

$H_b$  is the wave height at incipient breaking (wind generated significant wave height @ 3.2').

$\gamma_b$  is the breaker depth index for waves travelling over a horizontal bottom (McCowan 1891) @ 0.78 (unitless).

$d_b$  is the depth where the wind generated wave will break, calculated to be 4.1'.

The significant wave height is essentially the average of 2/3<sup>rd</sup>s of the waves propagated across the lake. This would indicate that during the storm waves were initially breaking at the toe of the littoral shelf and not on the face of the vertical retaining wall. However, as the waves continued their assault on the littoral shelf, eroding and flattening the surface, the incoming waves eventually reached the vertical wall, breaking directly on the face. The depth required for a breaking wave at 4.1' was deeper than the scour depth  $S_M$  @ 3.2'. This means that eventually the incoming waves were no longer breaking on the slope but directly impacting the retaining wall.



Additional scour at the toe was directly related to the elevation of the lake at the north end during the hurricane. We assumed that the lake was at the control elevation. However, there is also a storm surge component that was likely a contributing factor to failure of the seawall. The movement of the water across the surface of the lake for an extended duration essentially created a storm surge, captured by the north end of the lake, artificially increasing the elevation of the incoming waves, and potentially overtopping the retaining wall. A higher water elevation as show below would reduce the amount of scour at the base of the seawall but would overtop the wall with more consistency, adding an additional hydrostatic surcharge that would be significant once the wind speeds reduced or changed direction, significantly increasing the active earth loads on the retaining wall without having in passive earth pressures in front of the retaining wall as a result of the loss of the littoral shelf.

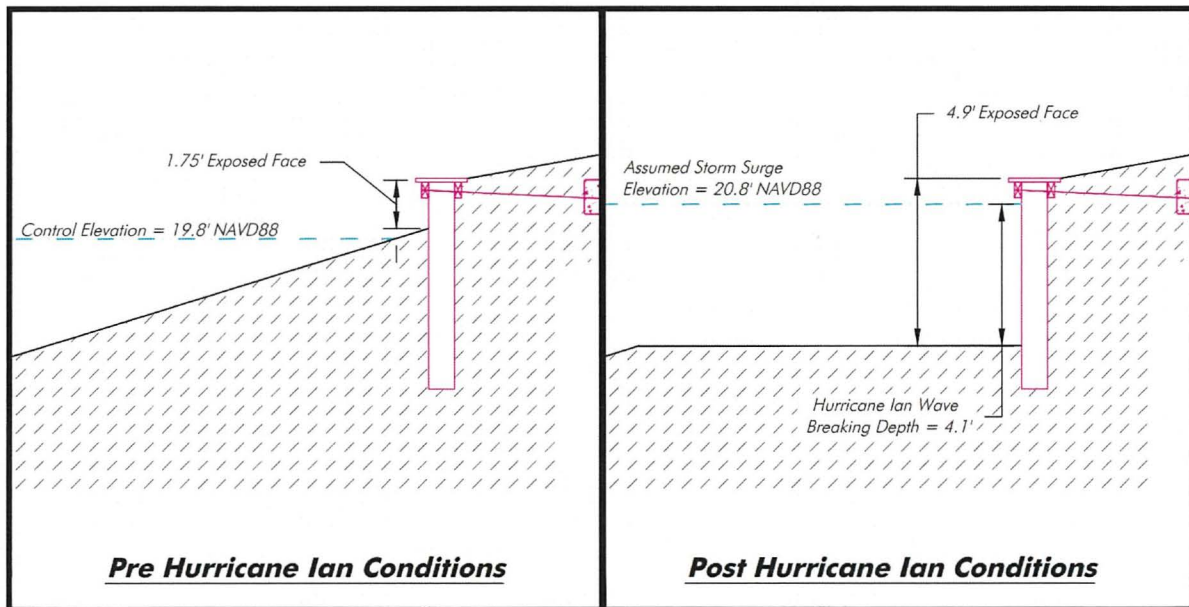

Because the slope of the littoral shelf is unprotected, any scour occurring will increase the depth of water and increase the height of wave that can be supported at the base of the structure. Consideration should be given to the fact that over the six hours of recorded wind speeds there was likely little in way of a protective shelf left in front of the retaining wall.

**DESIGN** – The retaining wall was designed to separate the upland development and toe of the berm forming the perimeter stormwater basin from the littoral shelf in the lake. The design consisted of a Vanguard Z vinyl panel embedded in the substrate. The top of the panel was attached, front and back, to a 2" x 6" board running the length of the seawall cap. The design included options for using either No. 1 Southern Yellow Pine or Weardeck synthetic boards. The horizontal board were connected to the vinyl panels using 1/2" dia. Stainless steel bolts. Deadmen were specified on 12' centers using 3/4" hot dipped galvanized threaded rod tie-backs terminating in a 12" x 12" by 24" long concrete deadman set a minimum 4' behind the retaining wall. The top of the cap was dressed with horizontal, synthetic deck boards attached perpendicular to the alignment of the retaining wall. Below is a cross section of the design, and representative details, certified by the engineer of record on February 6, 2020 for the north lake in Wild Blue.

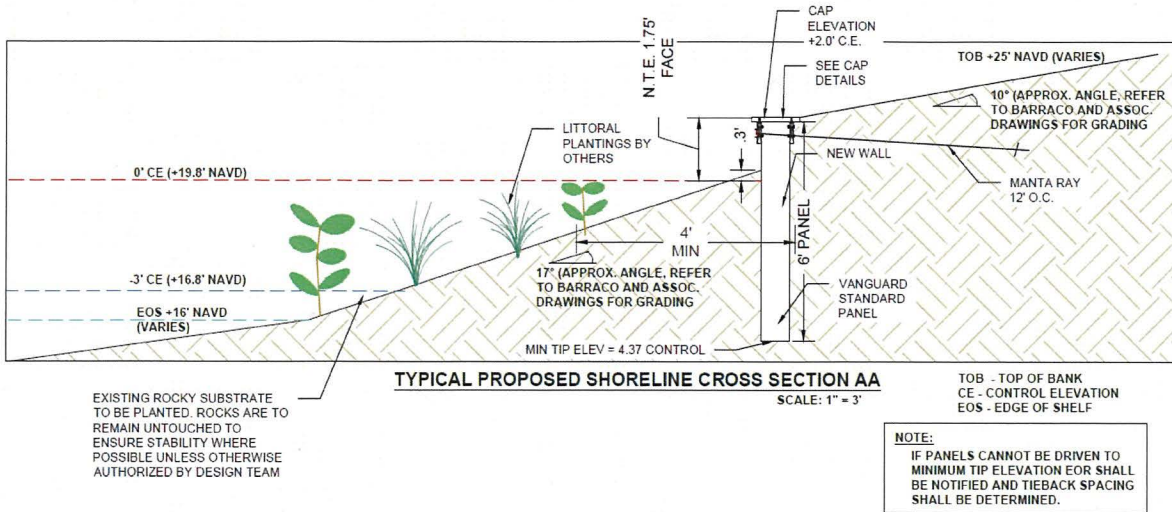

Below left is a top view of the vinyl panel and cap design. To the right is a cross section of the cap design and in the lower right is a cross section of the deadman design.

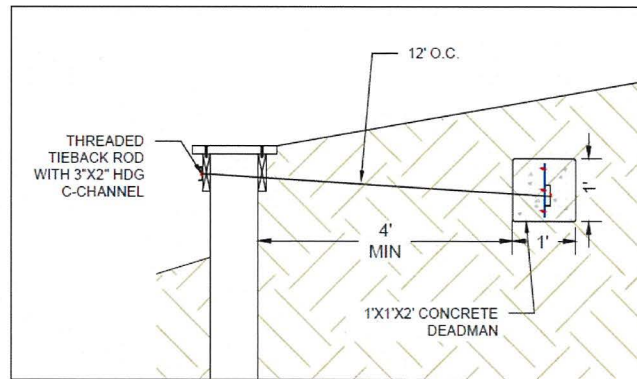
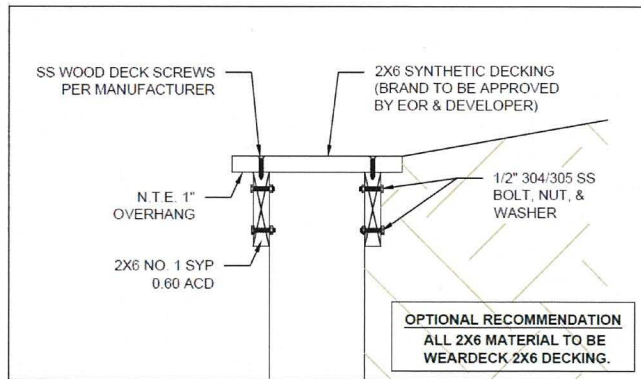
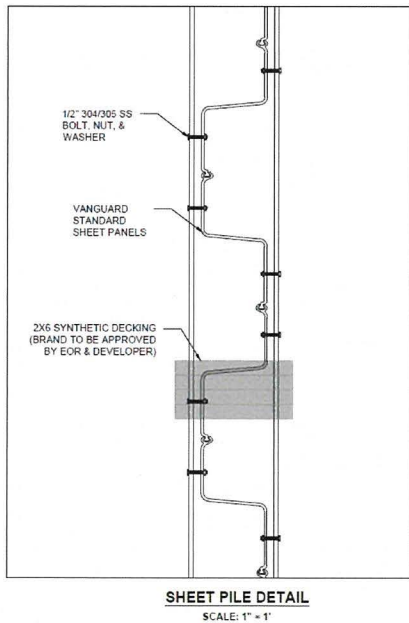

- NOTES:
- ◊ 4000 lb CONCRETE AT 28 DAYS
  - ◊ 3/4\"/>

**OBSERVATIONS** – We began our investigation along the north shore of the north lake on February 10, 2023, referring to the Blue Lake CDD Hurricane Damage Exhibit dated October 27, 2022 prepared by Barraco and Associates, Inc. We did not inventory the shoreline since this was already completed by Barraco. Our intent was to assess the



various failure modes and determine if the retaining wall failure was based solely on the impacts of the hurricane, a construction issue, a potential design flaw, or a combination of factors.

There are basically four conditions associated with the retaining wall. The first was the intended design condition. This consisted of the retaining wall at the base of the sloped berm constituting the perimeter of the stormwater management system. In front was a planted littoral shelf with a substrate consisting of sand, clay, and a variety of rock sizes. Below is a photo of the intended design. Note that the expose face, or the distance from the top of the retaining wall cap to the substrate on the waterward side, was minimal and consistent with the maximum of 1.75' allowed in the construction drawings.



As the profile in front of the seawall was lowered we observed failures in many different forms. Generally as the profile of the shoreline decreased or flattened, and the exposed face increased, the active load (landward side) on the wall increased. Generally when the exposed face reached 2.4' the deadmen held tight but the wall between the deadmen, set 12' on center, started to bow out. This can be seen as a scalloping of the top of the seawall cap. In the photo below, note the flat profile of the littoral shelf and water abutting the toe of the seawall panel. There is very little vegetation remaining at the base of the retaining wall and in this case the wall, depending on the control elevation of the lake, is now functioning as a seawall.





The next form of failure was loss of the deadmen. In the photo below the deadmen anchoring the retaining wall failed. It is likely that the saturated soil condition, either from rain fall, inundation from wave overtopping or both, eliminated the holding power of the soil in front of the face of the deadman, allowing them to move in the waterward direction. This then allowed the retaining wall to fall over rotating about the toe or bottom of the panels. There was not sufficient soil on the passive (waterward) side to counter the loss of the anchors. This was the most common failure mode. The areas that exhibited the most destruction were at the north end directly fronting the open waters of the lake. In some instances, particularly with the failure shown below, there was overtopping of the stormwater berm from the land side and discharge to the backside of the retaining wall, further saturating the soil and reducing the effectiveness of the dead men.





The next form of failure, as shown in the following photo, is where the scour at the toe of the retaining wall eliminated the littoral shelf and lowered the profile to the point that the toe of the wall kicked out. Note that the tie-backs and deadmen are still in place. This form of failure was uncommon. The previous failure was the more common condition indicating that the wind induced shift of the water surface from the south to the north induced a storm surge that likely overtopped the existing retaining wall, both lowering the profile in front and saturating the soil, reducing the effectiveness of the deadmen.



To the right is a graphic depicting a generalized erosion condition that reflects the observations on site. As the load on the wall increases, based on the scour and increased exposed face, the wall fails in two modes, both shown above. Either the deadman holds and the toe of the wall kicks out at the bottom or the deadman fails and the wall topples into the water as shown on the graphic.

The next step is to assess whether the seawall was designed for any anomalous conditions and whether it would even survive a summer storm, much less a hurricane. There appears to be a basic assumption that the existing ledge along the front of the retaining wall was of a substantive nature that it would resist incoming wave energy from seasonal storms and boat wakes. We can determine to what extent the wall would remain functional based on more exposed face.

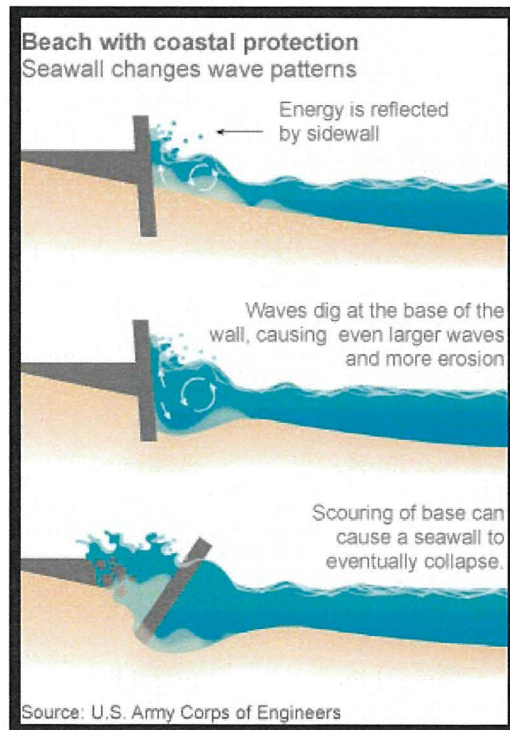

**RETAINING WALL DESIGN** – Referred to as service loads, these are the actual loads applied to the structure. The Allowable Stress Design (ASD) methodology determines the loads on the structure then the structure is designed to resist those loads. A Factor of Safety (FOS) is incorporated into the design for redundancy or for anomalous conditions.

Pile Buck produces a sheet pile design program called SPW911 that is used to design earth retaining walls. The program is used to calculate forces on a vertical retaining wall that assesses soils, hydrostatic loading, surcharge loads on the active (land side) of the wall, passive loads on the face of the wall, including water and earth loads. The program uses Rankin Earth Theory to evaluate the loads and establish the required resistances in terms of the moment capacity of the wall, the required retention at the top, the necessary penetration into the soil, the failure slope, and related factors. The following are conditions that were established by the design engineer and generally accepted engineering practices and factors utilized for an earth retaining wall design.

Exposed face – Design exposed face following an expected storm event as required by ASCE 7 and calculated utilizing methodology outlined in the Coastal Protection Manual.

110 lbs/ft<sup>3</sup> soil unit weigh – Typical soil unit weight expected for coarse sand observed at the site. Note that this changes under a saturated or underwater condition.

30° soil angle of internal friction – Typical soil unit weight expected for coarse sand observed at the site.

10° slope for landward soil – Per the design engineers construction plans.

6' Vanguard Standard Vinyl Panels – Per design engineers construction plans.

Saturated Soil Conditions – Per design engineers construction plans no weep holes were proposed to relieve hydrostatic pressure from the upland.

Passive Water Depth – This assumes a stabilized lake level following a design storm event but does not account for “sloshing” in the lake where the water is pushed up against one side or the other based on wind direction.

Surcharge Load – The retaining wall is located at the base of a berm that defines the stormwater management system. No significantly sized construction or vehicle uses are likely to occur on the landward side of the retaining wall other than mowers and light weight maintenance vehicle.

With these parameters, and a selected storm event agreed to with the owner, a final retaining wall design can be generated for a variety of conditions.

**Toe Kickout** – As discussed previously, one of the failure modes was loss of the retaining wall via kick out at the toe. If the wall does not have sufficient penetration into



the substrate, there is the potential that the passive loads on the face of the wall, (earth and/or water) may not be sufficient to resist the earth loads (active) the wall is intended to contain. As a result, the wall may kick out at the bottom. The Florida Building Code (Section 1807.2.3) requires a minimum Factor of Safety (FOS) of 1.5 to address kick out or rotation around the cap or top of the wall.

As previously discussed in the **WAVE CALCULATIONS** section, the design exposed face of 4.9' was the result of the amount of erosion and final depth at the base of the wall caused by the hurricane, which was (by calculation) 4.1'. The design length of the Vanguard Panels was 6', resulting in only 1.1' of embedment. This produces a FOS less than 1, which SPW911 will not display as a safety precaution for designers. The following calculations were performed utilizing SPW911:

Assuming a 4.9' exposed face the Vanguard Panels would need to be 9.36' long to provide a FOS of 1.5 from overturning

Given the 6' long panels the maximum exposed face would be 2.63' before the FOS against overturning was lower than 1.5. As previously noted, when the exposed face was greater than 2.4', the cap began to deform or curve out, exceeding the resistance capacity of the seawall panels.

The design was limited in some capacity by a rock layer as noted by the design engineer in the construction plans. To resist any kick out at the toe, when a panel encountered rock without adequate penetration, the bottom of the panel could be pinned in place using steel rebar that is driven into the rock substrate. A number of alternative panel types are available that allows for this option. Pinning the toe of the wall would prevent the kick out increasing the FOS of the design.

Alternatively, the design engineer could have specified riprap to be placed at the toe as a gravity load, also preventing kick out and attenuating incoming wave energy. This may have conflicted with the intent of the littoral shelf, but the rock could have been buried under the shelf and only exposed during a tropical event that eroded or removed the shelf. At least the wall would have remained in place relative to toe scour. The panel embedment depth per the design was insufficient given the scour conditions associated with the hurricane, or potentially a lesser summer storm or extended cold front, if the wave erosion eliminates or reduces the height of the littoral shelf. Any design with a FOS less than 1 is not acceptable.

**Retaining Wall Cap Deflection** – The cap of a retaining wall is connected to earth anchors, via tie-backs, that transfer the earth load on the wall outside of the failure slope. The cap design for this retaining wall consisted of 2" wide by 6" tall pressure treated Southern Yellow Pine boards located on the front and back side of the vinyl panels. The boards were connected to the panels with ½" dia. stainless bolts and the front board was connected to the earth anchors using a galvanized plate and ¾" dia. galvanized threaded rods. The design engineer allowed for either wood or composite materials of the same dimension to be used as the cap. The top of the cap was specified to have composite 2" x 6" boards bridging across the top of the vinyl panels, connected to the outer and inner cap boards.

As the active load on the retaining wall decreased from erosion of the littoral shelf, the passive load increased. While the earth anchors held firm where they are attached to the cap, a noticeable bend in the cap was observed, equidistant from where the earth anchors were attached. The 2" x 6" boards provided limited resistance to the bending action, with the 2" thick section of the board providing the only resistance to the bending. This was most noticeable where the exposed face exceeded 2.4'. As the exposed face increased the curve became more pronounced and in some cases the wall failed.



*To the left is a photo of the retaining wall failure where the earth anchors and tie-backs, circled in red, held but the active load exceeded both the capacity of the seawall panel and the cap boards. Note the floating debris still remaining landward of the retaining wall, indicating that the wall was submerged at some point during the hurricane.*

**REPAIR OPTIONS** – In most cases the retaining wall is still functioning to varying degrees. Those that retain a wide littoral shelf in front will continue to perform as designed. As the exposed face increases past 2.4', the top of the retaining wall cap will begin to deflect and will increase that deflection as the exposed face increases. For those sections that remain intact, excavating behind the retaining wall to reduce the active loads and adding an intermediate deadman either in the form of a concrete block, helical, or Manta Ray to perform as an additional earth anchor can address the deflection. Alternatively, a more robust beam at the top of the cap that can transfer the earth loads to the existing deadmen would also address the deflection, up to a point. The question becomes, how straight does the owner want the top of the cap to appear and will the deadmen hold that additional load as the exposed face increases. Initial calculations indicate that the deadmen are less than a foot outside of the failure slope.



For the areas where the retaining wall was destroyed, removal of the panels in their entirety and starting over is the only choice. Consideration should be given to a number of variables regarding how to address the shoreline. They include restoring the littoral shelf and how to protect it; what level storm is the owner willing accept for the engineering design; consideration of how to pin the toe of the retaining wall in the event of a similar return storm event; consideration of the saturated soil condition that occurs during a similar event and how that affects the retaining wall earth anchor design; and most importantly, where on the lake to construct a more robust design to address the configuration of the lake and the longer fetch distances from the north to south alignment.

It is typically not feasible, based on cost, to design to a Category 4 hurricane impact, particularly for over 6 miles of retaining wall. Given that the expected life for a retaining wall or seawall structure is typically 40 to 50 years, we looked at 40 years of wind hindcasts at Southwest Florida International Airport. We narrowed the assessment to wind direction from either the north or south and determined there were a number of significant events that exceeded the average summer thunderstorm or winter cold front.

Wind Speed	Wind Direction	Date of Observation
119.6 MPH	0° (north)	3/13/1998
80.5 MPH	10° (north)	1/10/1998
65.5 MPH	360° (north)	9/4/1996
62.1 MPH	180° (south)	7/2/1993

There are eleven recordings of winds blowing 50 MPH or greater during this hind-cast. At a minimum, the replacement wall should be sufficient to withstand the waves generated by a 50 MPH storm event, which is very likely to occur during the walls design life. This design criteria should be applied to both the north and south shorelines.

Consistent with repair options is determining how best to address protection of the littoral shelves. Once they are restored and replanted, we suggest armoring the waterward side to attenuate the wave energy created by the design wind loads. They are the first line of defense against lowering the exposed face of the retaining wall.

Also, we need to consider the impact of boats in the waterway. Boat wakes, unless attenuated, will continue to erode the entire shoreline. Stabilization of the substrate prior to planting or implementation of the breakwater, will be necessary to prolong the life of the installation and protect the retaining wall.

There are many variations on the design that would be applicable to the north and south lakes at Wild Blue. It is dependent on the profile of the shoreline and includes aesthetic issues related to exposure at the toe during the winter months when the lakes are seasonally lower and more shoreline is exposed. The profile of the littoral shelf is also important relative to what type of plant species are intended to be installed and how that affects views over the lake. Plant type is also important in terms of root structure and the ability to hold the soil during typical windy days and impacts from boat wakes. Below is a typical example of an attenuating breakwater.

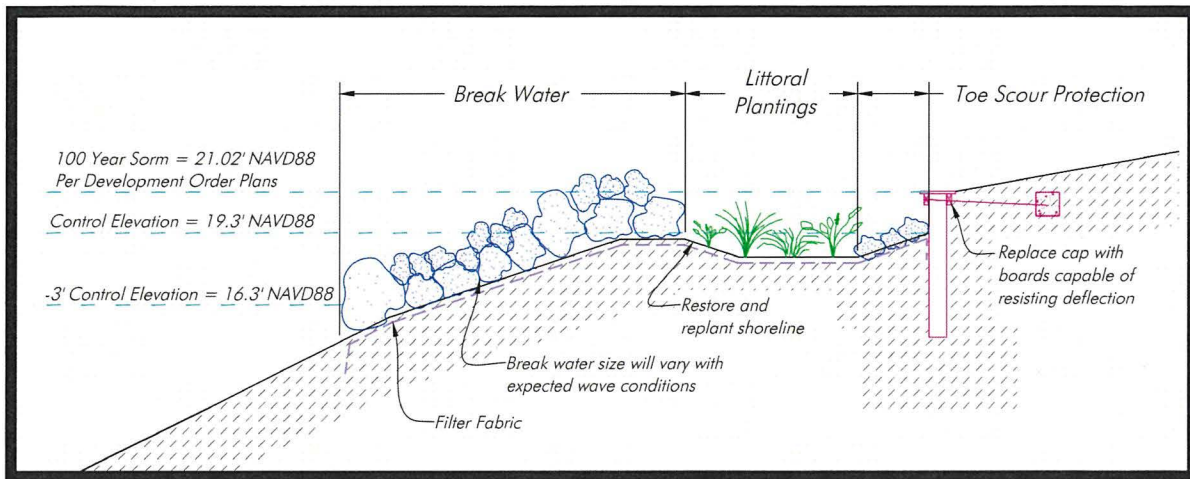

This typical cross section would be modified on a case by case basis. For areas where the shelf between the drop off into the deeper waters of the lake and the upland retaining wall is flat, a smaller pyramid shaped rock structure could be constructed and would hold the toe of the littoral shelf.

Areas where additional wave attenuation should be considered are shown by the purple line on the LEEPA graphic below. This constitutes about 1,650 lf. of shoreline for the north lake and 1,250 lf. for the south lake. A more thorough assessment by the design engineer may yield modifications to this recommended repair plan.





**OPINION OF PROBABLE COST** – The most recent costs for vinyl seawall panel installations applied to the current design will run between \$600 and \$700 per linear foot for a replacement retaining wall. Pricing right now is a challenge because of material costs, supply chain issues, and availability of contractors. Most contractors are not holding to their pricing for more than 60 days for this reason.

In some cases, the existing vinyl panels and associated hardware could be salvaged and reused. This would be an option if material availability is limited. Generally, it is cheaper to build new and scrap the old based on labor costs. We would assume a demolition cost of \$25/lf. to remove the debris and truck off site.

For areas where the rock layer prevents sufficient penetration, a pin pile insert can be installed in the Vanguard panels and a Schedule 80 pipe pile driven to pin the toe. A box section vinyl seawall panel could also be used with steel rebar set inside and driven into the rock a minimum of 18". In most cases these box panels are filled with concrete to encase the steel and add strength to the panel. In all cases, restoration of the retaining wall will require that the littoral shelf is reconstructed and the exposed face reduced to the design maximum of 1.75' if restoring the retaining wall to the original design.

A mounded riprap breakwater would run around \$500 a linear foot for the approximate 2,850 lf. of shoreline at the north and south extents. Repairs to the seawall involving the placement of additional tiebacks are going to run about \$1,500 per tie-back. In lieu of the additional tie-back, a stronger cap board to resist the bending moment between tiebacks could be utilized. This is dependent on the viability of the deadmen and holding capacity. At this point, which walls to stabilize and which walls to replace is going to be subjective depending on the owner's desires and pocketbook. It will also depend on the final design criteria acceptable to the client. If the wall was insured, there is no question that the majority of the wall failure resulted from the impact of the hurricane. Once a work plan is devised on what the owner wants to do to facilitate repairs and/or replacement, a more specific Opinion of Probable Cost can be prepared.

**SUMMARY** – Hurricane Ian was a Category 4 hurricane that had a devastating impact on Lee County. Many consider it a 500 year return storm event. However, hurricanes are a way of life in Florida and need to be accounted for in any marine related design.

More importantly, a design needs to be considered specific to the site and the factors that affect the shoreline. Clearly the north to south alignment of the lakes presents a significant fetch distance that can amount to significant wave heights. These wind driven waves have an erosive power that is capable of overwhelming the stability of the soils used to create the littoral shelves along the shoreline around the lake. The littoral shelves, when totally populated with the proper plant species, are an effective tool in helping attenuate wind driven wave energy generated daily. However, they need toe stability in those areas subject to large fetch distances.

Depending on the use of boats on the lake, boat wakes will also have a deleterious impact on the shoreline. This is particularly true if specialty boats for wakeboarding are used. They are designed to create a large wake for the sport.

We would recommend reassessing the north and south shorelines for stability options that are robust enough to withstand the higher seasonal wind speeds associated with cold fronts and summer storm fronts, and subsequent waves that will occur. The current design is appropriate for stable shorelines in small lakes and detention ponds but not for open shorelines facing large fetch distances. And the impact of boats in the lakes also needs to be taken into account as an additional erosion source.

**CAVEAT** - The information contained within this report is developed from various public information sources and is accurate to the best of our knowledge and understanding. This information package is intended to assist the client while evaluation retaining wall repair options and does not constitute an engineered design.

Reviewed By:

Prepared By:

*Jack Walter*

Jack Walter, Project Manager  
Florida Engineering Intern  
#1100024576

Hans JM  
Wilson

Digitally signed by  
Hans JM Wilson  
Date: 2023.03.07  
09:44:19 -05'00'

Hans Wilson, P.E.  
Florida Registered Engineer #39680

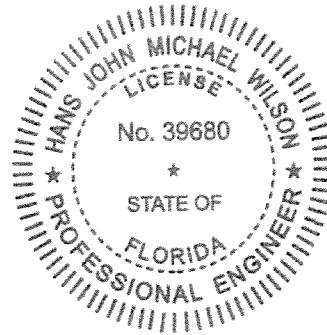



## REFERENCES

NOAA National Centers for Environmental Information, Monthly National Climate Report for September 2022, published online October 2022, from <https://www.ncei.noaa.gov/access/monitoring/monthly-report/national/202209/supplemental>

U.S. Army Corps of Engineers. (1984). *Shore Protection Manual Volume 1 (page 3-55, 3-65)*. Vicksburg, MS. Coastal Engineering Research Center.

The Florida Building Commission. (2020). *The Florida Building Code, Building, 7<sup>th</sup> Edition*. Tallahassee, FL.

American Society of Civil Engineers (2010). *ASCE Standards ASCE/SEI 7-10*. Reston, VA.

Federal Emergency Management Agency (2008). *FIRM Panel 12071C0625F*. Retrieved March 3, 2023, from FEMA Flood Map Web Site: <https://msc.fema.gov/portal/search?AddressQuery=fort%20myers#searchresultsanchor>

U.S. Army Corps of Engineers. (2002). *Coastal Engineering Manual Part VI*. Washington, DC.

U.S. Army Corps of Engineers. (2002). *Coastal Engineering Manual Part II*. Washington, DC.

U.S. Army Corps of Engineers. (1995). *Design of Coastal Revetments, Seawalls, and Bulkheads*. Washington, DC.

Southwest Florida International Airport (1983-2020). *Historic Wind Data*. Retrieved March 3, 2023, From Iowa State University Website: [https://mesonet.agron.iastate.edu/sites/site.php?station=RSW&network=FL\\_ASOS](https://mesonet.agron.iastate.edu/sites/site.php?station=RSW&network=FL_ASOS)

Fetch and Depth Limited Waves – Woods Hole Coastal and Marine Science Center – <http://csherwood-usgs.github.io/jsed/Fetch%20and%20Depth%20Limited%20Waves.%20USGS.html>